

Layout

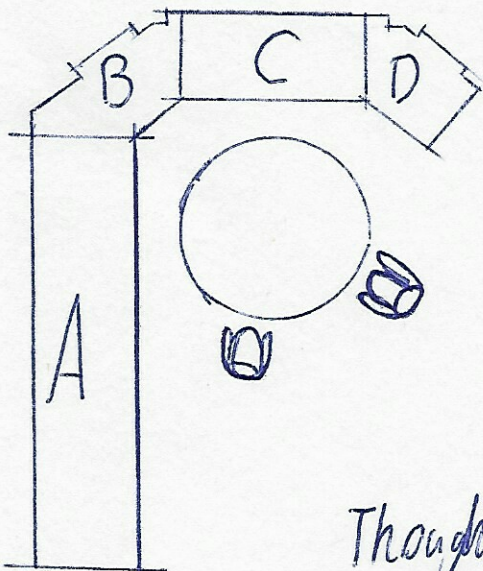

Thought:
Take 1" off interior
and side dimensions.
Maybe .5" of Back dimensions

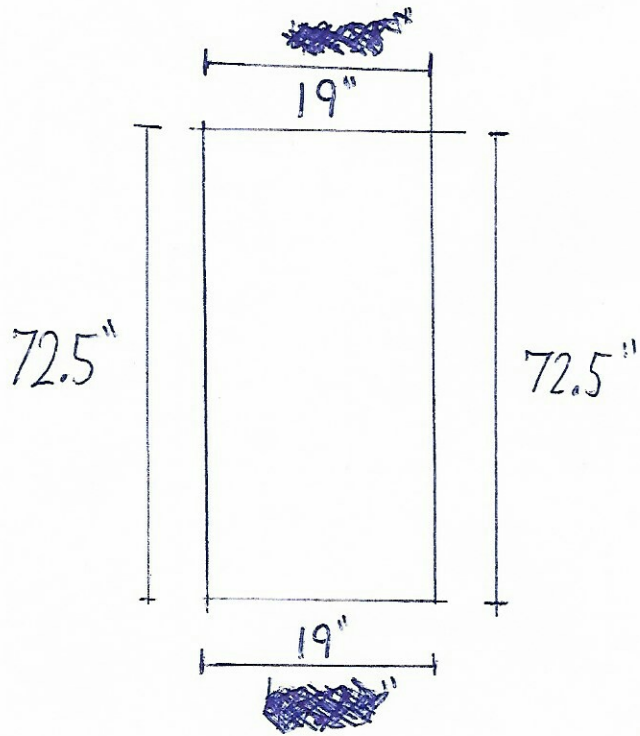

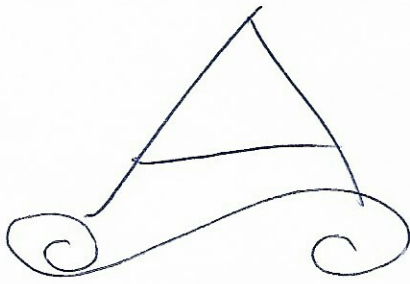
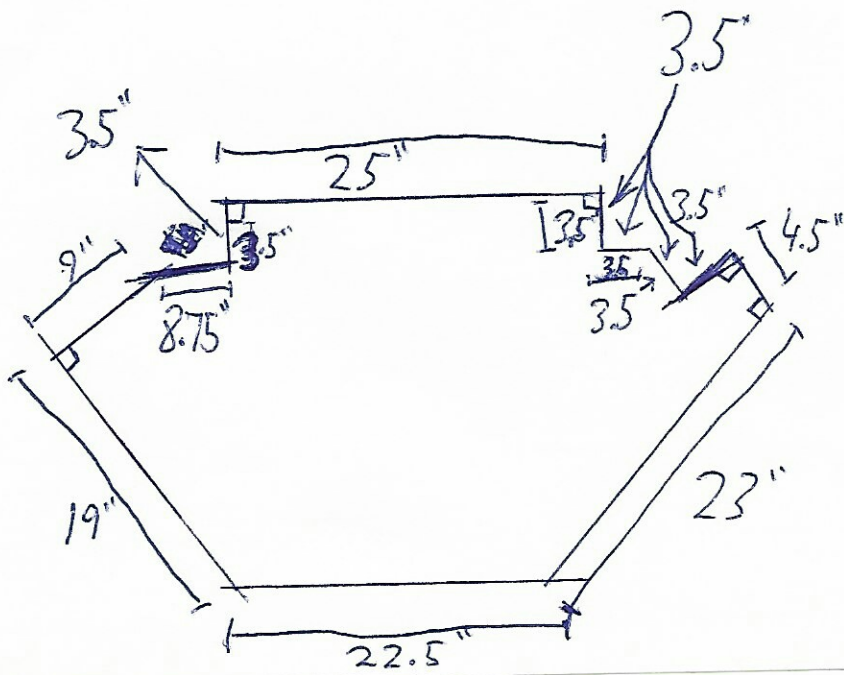
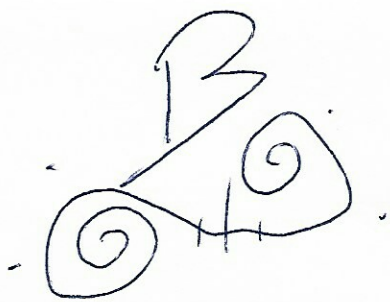

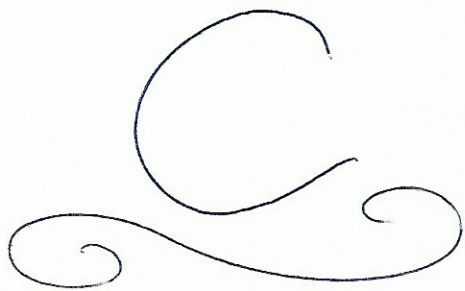

40.25"

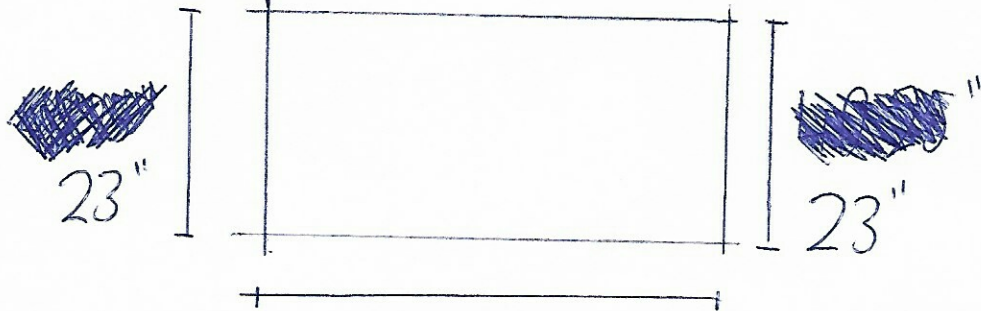

23"

23"

40.25"

